

The software of this player may be updated in the future. To find out details on any available updates, please visit: <http://www.sony.com/bluraysupport/>



<http://www.sony.net/>

Printed on 70% or more recycled paper using VOC (Volatile Organic Compound)-free vegetable oil based ink.

4-169-144-11(1)



1-416914411

Printed in Malaysia

Operating Instructions

Blu-ray Disc™ / DVD Player

BDP-S570/BX57

WARNING

To reduce the risk of fire or electric shock, do not expose this apparatus to rain or moisture.

To avoid electrical shock, do not open the cabinet. Refer servicing to qualified personnel only.

The AC power cord must be changed only at a qualified service shop.

Batteries or batteries installed apparatus shall not be exposed to excessive heat such as sunshine, fire or the like.

CAUTION

The use of optical instruments with this product will increase eye hazard. As the laser beam used in this Blu-ray Disc/DVD player is harmful to eyes, do not attempt to disassemble the cabinet. Refer servicing to qualified personnel only.



This label is located on the laser protective housing inside the enclosure.

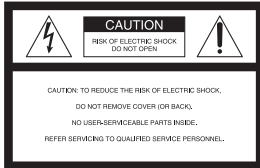

This symbol is intended to alert the user to the presence of uninsulated “dangerous voltage” within the product’s enclosure that may be of sufficient magnitude to constitute a risk of electric shock to persons.



This symbol is intended to alert the user to the presence of important operating and maintenance (servicing) instructions in the literature accompanying the appliance.

Precautions

- To prevent fire or shock hazard, do not place objects filled with liquids, such as vases, on the apparatus.
- Install this unit so that the AC power cord can be unplugged from the wall socket immediately in the event of trouble.

Operation is subject to the following two conditions;
(1) this device may not cause interference, and
(2) this device must accept any interference received, including interference that may cause undesired operation of the device.

FCC WARNING

You are cautioned that any changes or modifications not expressly approved in this manual could void your authority to operate this equipment.

This transmitter must not be co-located or operating in conjunction with any other antenna or transmitter.

The shielded Interface cable (LAN cable) must be used with the equipment in order to comply with the limits for a digital device pursuant to Subpart B of Part 15 of FCC Rules.



This equipment has been tested and found to comply with the limits for a Class B digital device, pursuant to Part 15 of the FCC Rules. These limits are designed to provide reasonable protection against harmful interference in a residential installation. This equipment generates, uses, and can radiate radio frequency energy and, if not installed and used in accordance with the instructions, may cause harmful interference to radio communications.

However, there is no guarantee that interference will not occur in a particular installation. If this equipment does cause harmful interference to radio or television reception, which can be determined by turning the equipment off and on, the user is encouraged to try to correct the interference by one or more of the following measures:

- Reorient or relocate the receiving antenna.
- Increase the separation between the equipment and receiver.
- Connect the equipment into an outlet on a circuit different from that to which the receiver is connected.
- Consult the dealer or an experienced radio/TV technician for help.

FCC Radiation Exposure

Statement:

This equipment complies with FCC radiation exposure limits set forth for uncontrolled equipment and meets the FCC radio frequency (RF) Exposure Guidelines in Supplement C to OET65. This equipment should be installed and operated with at least 20 cm and more between the radiator and person’s body (excluding extremities: hands, wrists, feet and ankles).

IC Radiation Exposure

Statement:

This equipment complies with IC radiation exposure limits set forth for uncontrolled equipment and meets RSS-102 of the IC radio frequency (RF) Exposure rules. This equipment has very low levels of RF energy that it deemed to comply without maximum permissive exposure evaluation (MPE). But it is desirable that it should be installed and operated with at least 20 cm and more between the radiator and person’s body (excluding extremities: hands, wrists, feet and ankles).

When using the unit, use indoors.

Contains FCC ID :
EW4DWMW034
Contains IC : 4250A-
DWMW034

This class B digital apparatus complies with Canadian ICES-003.

Owner’s Record

The model and serial numbers are located at the rear of the unit. Record the serial number in the space provided below. Refer to them whenever you call upon your Sony dealer regarding this product.

Model No. _____
Serial No. _____

For customers in the USA

If this product is not working properly, please call 1-866-909-7669.

For Customers in Canada

If this product is not working properly, please call 1-877-602-2008 for **Peace of Mind Warranty Replacement service.**

For other product related questions please contact our **Customer Information Service Center** at 1-877-899-7669 or write to us at: Customer Information Service 115 Gordon Baker Road, Toronto, Ontario, M2H 3R6

Notes About the Discs

- To keep the disc clean, handle the disc by its edge. Do not touch the surface. Dust, fingerprints, or scratches on the disc may cause it to malfunction.



- Do not expose the disc to direct sunlight or heat sources such as hot air ducts, or leave it in a car parked in direct sunlight as the temperature may rise considerably inside the car.
- After playing, store the disc in its case.
- Clean the disc with a cleaning cloth. Wipe the disc from the center out.



- Do not use solvents such as benzine, thinner, commercially available disc/lens cleaners, or anti-static spray intended for vinyl LPs.
- If you have printed the disc's label, dry the label before playing.
- Do not use the following discs.
 - A lens cleaning disc.
 - A disc that has a non-standard shape (e.g., card, heart).
 - A disc with a label or sticker on it.
 - A disc that has cellophane tape or sticker adhesive on it.
- Do not resurface the playing side of a disc to remove surface scratches.

Precautions

On placement

- Place the player in a location with adequate ventilation to prevent heat build-up in the player.
- Do not place the player on a soft surface such as a rug that might block the ventilation holes.
- Do not install this player in a confined space, such as a bookshelf or similar unit.
- Do not place the player in a location near heat sources, or in a place subject to direct sunlight, excessive dust, or mechanical shock.
- Do not place the player outdoors, in vehicles, on ships, or on other vessels.
- If the player is brought directly from a cold to a warm location, or is placed in a very damp room, moisture may condense on the lenses inside the player. Should this occur, the player may not operate properly. In this case, remove the disc and leave the player turned on for about half an hour until the moisture evaporates.
- Do not install the player in an inclined position. It is designed to be operated in a horizontal position only.
- Do not place metal objects in front of the front panel. It may limit reception of radio waves.
- Do not place the player in a place where medical equipment is in use. It may cause a malfunction of medical instruments.

- If you use a pacemaker or other medical device, consult your physician or the manufacturer of your medical device before using the wireless LAN function.
- Do not place heavy or unstable objects on the player.
- Do not place any objects other than discs on the disc tray. Doing so may cause damage to the player or the object.
- Take out any discs when you move the player. If you don't, the disc may be damaged.
- Disconnect the AC power cord and all other cables from the player when you move the player.

On power sources

- The player is not disconnected from the AC power source as long as it is connected to the wall outlet, even if the player itself has been turned off.
- Disconnect the player from the wall outlet if you are not going to use the player for a long time. To disconnect the AC power cord, grasp the plug itself; never pull the cord.
- Observe following points to prevent the AC power cord being damaged. Do not use the AC power cord if it is damaged, as doing so may result in an electric shock or fire.
 - Do not pinch the AC power cord between the player and wall, shelf, etc.
 - Do not put anything heavy on the AC power cord or pull on the AC power cord itself.

On adjusting volume

Do not turn up the volume while listening to a section with very low level inputs or no audio signals. If you do, your ears and the speakers may be damaged when a peak level section is played.

On cleaning

Clean the cabinet, panel, and controls with a soft cloth. Do not use any type of abrasive pad, scouring powder or solvent such as alcohol or benzine.

On cleaning discs, disc/lens cleaners

Do not use cleaning discs or disc/lens cleaners (including wet or spray types). These may cause the apparatus to malfunction.

On replacement of parts

In the events that this player is repaired, repaired parts may be collected for reuse or recycling purposes.

On connecting to the HDMI OUT jack

Observe the following as improper handling may damage the HDMI OUT jack and the connector.

- Carefully align the HDMI OUT jack on the rear of the player and the HDMI connector by checking their shapes. Make sure the connector is not upside down or tilted.

HDMI OUT

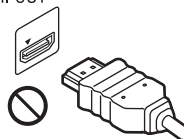

HDMI OUT

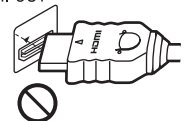

- Be sure to disconnect the HDMI cable when moving the player.



- Hold the HDMI connector straight when connecting or disconnecting the HDMI cable. Do not twist or force the HDMI connector into the HDMI OUT jack.

IMPORTANT NOTICE

Caution: This player is capable of holding a still video image or on-screen display image on your television screen indefinitely. If you leave the still video image or on-screen display image displayed on your TV for an extended period of time you risk permanent damage to your television screen. Plasma display panel televisions and projection televisions are susceptible to this.

If you have any questions or problems concerning your player, please consult your nearest Sony dealer.

Important Safety Instructions

- 1) Read these instructions.
- 2) Keep these instructions.
- 3) Heed all warnings.
- 4) Follow all instructions.
- 5) Do not use this apparatus near water.
- 6) Clean only with dry cloth.
- 7) Do not block any ventilation openings. Install in accordance with the manufacturer's instructions.
- 8) Do not install near any heat sources such as radiators, heat registers, stoves, or other apparatus (including amplifiers) that produce heat.
- 9) Do not defeat the safety purpose of the polarized or grounding-type plug. A polarized plug has two blades with one wider than the other. A grounding type plug has two blades and a third grounding prong. The wide blade or the third prong are provided for your safety. If the provided plug does not fit into your outlet, consult an electrician for replacement of the obsolete outlet.
- 10) Protect the power cord from being walked on or pinched particularly at plugs, convenience receptacles, and the point where they exit from the apparatus.
- 11) Only use attachments/ accessories specified by the manufacturer.
- 12) Use only with the cart, stand, tripod, bracket, or table specified by the manufacturer, or sold with the apparatus. When a cart is used, use caution when moving the cart/apparatus combination to avoid injury from tip-over.



- 13) Unplug this apparatus during lightning storms or when unused for long periods of time.
- 14) Refer all servicing to qualified service personnel. Servicing is required when the apparatus has been damaged in any way, such as power-supply cord or plug is damaged, liquid has been spilled or objects have fallen into the apparatus, the apparatus has been exposed to rain or moisture, does not operate normally, or has been dropped.

Table of Contents

| | |
|-----------------------------------|---|
| WARNING | 2 |
| Precautions | 4 |
| Guide to Parts and Controls | 8 |

Hookups and Settings

| | |
|-------------------------------------|----|
| Step 1: Preparing the Player | 11 |
| Step 2: Connecting the Player | 12 |
| Step 3: Easy Setup | 14 |
| Connecting to the Network | 15 |

Playback

| | |
|---------------------------------|----|
| Playing a Disc | 16 |
| Playing from a USB Device | 17 |
| Playing via a Network | 18 |
| Available Options | 18 |

Settings and Adjustments

| | |
|-----------------------------------|----|
| Using the Settings Displays | 20 |
| Network Update | 21 |
| Screen Settings | 21 |
| Audio Settings | 23 |
| BD/DVD Viewing Settings | 24 |
| Parental Control Settings | 24 |
| Music Settings | 25 |
| System Settings | 25 |
| Network Settings | 26 |
| Easy Setup | 27 |
| Resetting | 27 |

Additional Information

| | |
|-----------------------|----|
| Troubleshooting | 28 |
| Specifications | 32 |
| Index | 38 |

Guide to Parts and Controls

Front panel

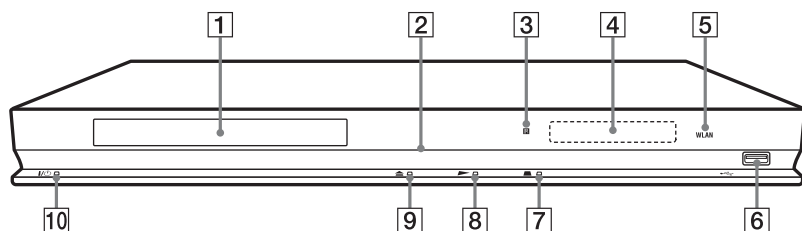

The ► button has a tactile dot. Use the tactile dot as a reference when operating the player.

- | | |
|--|---|
| 1 Disc tray | 6 ◀ (USB) jack Connect a USB device to this jack. |
| 2 Power indicator Lights up in white when the player is turned on. | 7 ■ (stop) |
| 3 Remote sensor | 8 ► (play) |
| 4 Front panel display ▶, ■: Lights up during playback or pause. ◀: Lights up when enabling the repeat setting. HD: Lights up when outputting 720p/1080i/1080p video signals. | 9 ▲ (open/close) |
| 5 WLAN indicator Lights up when using a wireless LAN. | 10 I/⏻ (on/standby) Turns on the player, or sets to standby mode. |

To lock the disc tray (Child Lock)

You can lock the disc tray to prevent it being opened by mistake.

When the player is turned on, hold down ► on the player for more than 10 seconds. The disc tray is locked or unlocked.

Rear panel

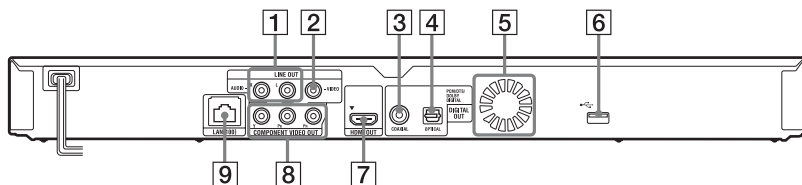

- | | |
|-------------------------------------|--|
| 1 LINE OUT (R-AUDIO-L) jacks | 6 ◀ (USB) jack |
| 2 LINE OUT (VIDEO) jack | 7 HDMI OUT jack |
| 3 DIGITAL OUT (COAXIAL) jack | 8 COMPONENT VIDEO OUT (Y, P_B, P_R) jacks |
| 4 DIGITAL OUT (OPTICAL) jack | 9 LAN (100) terminal |
| 5 Ventilation holes | |

Remote

The available functions of the remote differ depending on the disc or the situation.

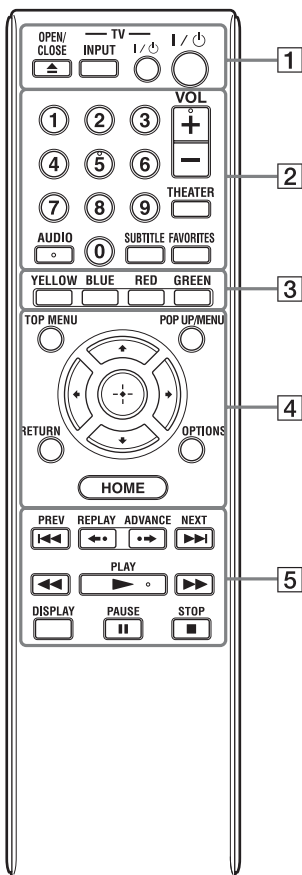

Number 5, AUDIO, VOL +, and ► PLAY buttons have a tactile dot. Use the tactile dot as a reference when operating the player.

The player automatically returns to standby mode

If any button on the player or remote is not pressed for more than 30 minutes, the player automatically returns to standby mode.

1 ▲ OPEN/CLOSE

Opens or closes the disc tray.

-TV- INPUT

Switches between TV and other input sources.

-TV- I/⏻ (on/standby)

Turns on the TV, or sets to standby mode.

I/⏻ (on/standby)

Turns on the player, or sets to standby mode.

2 Number buttons (0 - 9)

Enters the title/chapter numbers, etc.

VOL +/-

Adjusts the TV volume.

THEATER (page 34)

Switches to the optimum video mode for watching movies automatically.

The THEATER button functions only when connected to a Sony Theater Mode-compatible AV amplifier (receiver) or Sony Theater Mode-compatible TV.

AUDIO (page 24)

Selects the language track when multi-lingual tracks are recorded on BD-ROMs/DVD VIDEOS.

Selects the sound track on CDs.

SUBTITLE (page 24)

Selects the subtitle language when multi-lingual subtitles are recorded on BD-ROMs/DVD VIDEOS.

FAVORITES (page 18)

Displays the Internet content added to the Favorites List. You can save up to 18 of your favorite Internet content programs.

3 Color buttons (YELLOW/BLUE/RED/GREEN)

Short cut keys for interactive functions.

4 TOP MENU

Opens or closes the BD's or DVD's Top Menu.

POP UP/MENU

Opens or closes the BD-ROM's Pop-up Menu, or the DVD's menu.

OPTIONS (page 18)

The options menu that can be selected appears on the screen.

HOME

Enters the player's home menu.
Displays the wall paper when pressed on the category icon of the home menu.

RETURN

Returns to the previous display.



Moves the highlight to select a displayed item.

Center button (ENTER)

Enters the selected item.

5 ◀◀ PREV/NEXT ▶▶

Skips to the previous/next chapter, track, or file.

◀◀ REPLAY/ADVANCE ▶▶

Briefly replays the current scenes for 10 seconds/briefly fast forwards the current scenes for 15 seconds.

◀◀/▶▶ (fast reverse/fast forward)

- Fast reverses/fast forwards the disc when pressed during playback. Each time you press the button during playback of videos, the search speed changes.
- Plays in slow motion, when pressed for more than one second in pause mode.
- Plays one frame at a time, when pressed briefly in pause mode.

▶▶ PLAY

Starts or re-starts playback.

DISPLAY (page 17)

Displays the playback information on the screen.

|| PAUSE

Pauses or re-starts playback.

■ STOP

Stops playback and remembers the stop point (resume point).

The resume point for a title/track is the last point you played or the last photo for a photo folder.

Home menu display

The home menu appears when you press HOME. Select a category using ◀/▶. Select an item using ↑/↓, and press ENTER.

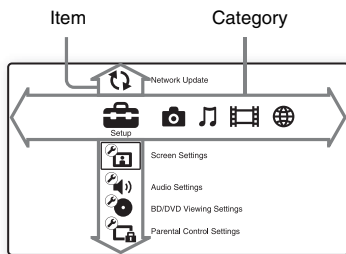

- (Setup): Adjusts the player settings.
- (Photo): Displays photos.
- (Music): Plays music.
- (Video): Plays videos.
- (Network): Displays network items.

Step 1: Preparing the Player

Checking the supplied accessories

Check that you have the following items:

- Audio/video cable (phono plug x3) (1)
- HDMI cable (1) (BDP-BX57 only)
- Remote commander (remote) (1)
- Size AA (R6) batteries (2)

Preparing the remote

Insert two Size AA (R6) batteries by matching the ⊕ and ⊖ ends on the batteries to the markings inside the battery compartment.

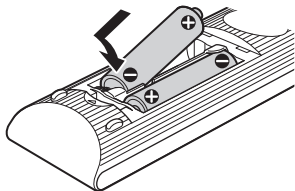

Step 2: Connecting the Player

Do not connect the AC power cord until you have made all the connections.

Connecting to your TV

Select one of the following connection methods according to the input jacks on your TV. Match the color of the plug to that of the jack when connecting.

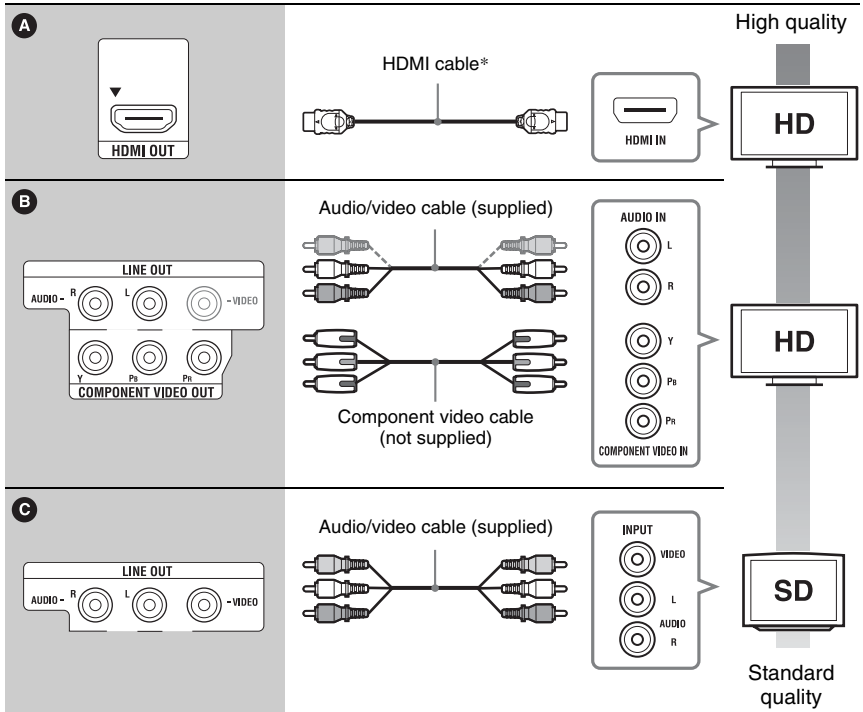
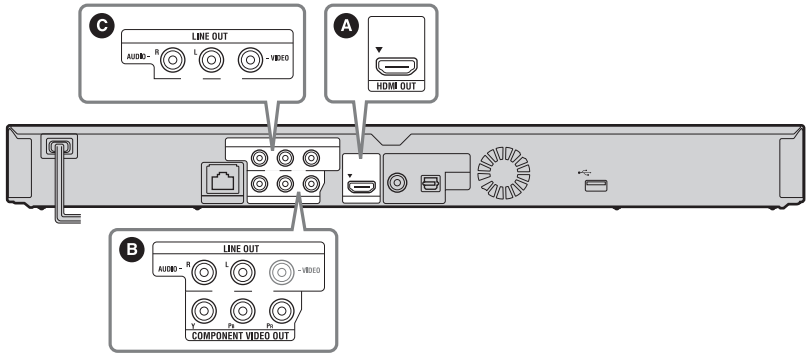

* See "Checking the supplied accessories" (page 11).



Do not connect the player through a VCR. Video signals fed through VCRs may be affected by copyright protection systems and the picture will be distorted on the television.

Connecting to your AV amplifier (receiver)

Select one of the following connection methods according to the input jacks on your AV amplifier (receiver). When you select **A** or **B**, make the appropriate settings in the “Audio Settings” setup (page 23).

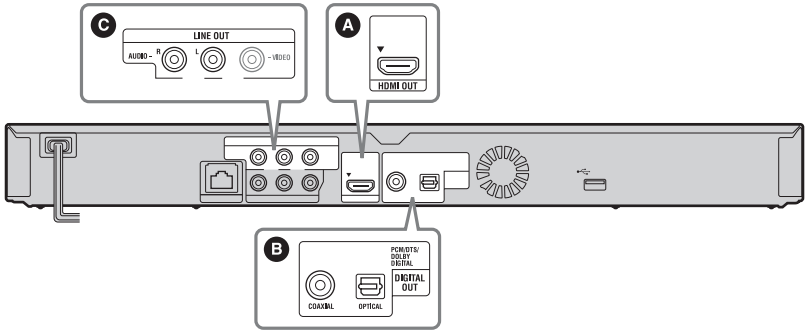

| | |
|-----------------|---|
| <p>A</p> | <p>HDMI cable*¹</p> <p>HDMI IN</p> <p>HDMI OUT</p> <p>HDMI cable (not supplied)</p> <p>HDMI IN</p> <p>→ Set “BD Audio MIX Setting” (page 23).</p> |
| <p>B</p> | <p>Coaxial digital cable (not supplied)</p> <p>or</p> <p>Optical digital cable (not supplied)</p> <p>DIGITAL IN</p> <p>COAXIAL</p> <p>OPTICAL</p> <p>→ Set “Dolby Digital (Coaxial / Optical)”^{*2} (page 23) and “DTS (Coaxial / Optical)”^{*3} (page 23).</p> |
| <p>C</p> | <p>Audio/video cable (supplied)</p> <p>AUDIO IN</p> <p>L</p> <p>R</p> |

*¹ See “Checking the supplied accessories” (page 11).

*2 Manufactured under license from Dolby Laboratories.

Dolby, Pro Logic, and the double-D symbol are trademarks of Dolby Laboratories.

*3 Manufactured under license under U.S. Patent #'s: 5,451,942; 5,956,674; 5,974,380; 5,978,762; 6,226,616; 6,487,535; 7,212,872; 7,333,929; 7,392,195; 7,272,567 & other U.S. and worldwide patents issued & pending. DTS is a registered trademark and the DTS logos, Symbol, DTS-HD and DTS-HD Master Audio are trademarks of DTS, Inc.

© 1996-2008 DTS, Inc. All Rights Reserved.

Step 3: Easy Setup

When turned on for the first time

Wait for a short while before the player turns on and starts "Easy Setup."

1 Plug the player into the AC outlet.

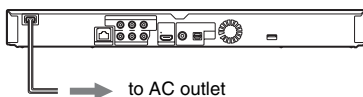

2 Press I/⏻ to turn on the player.

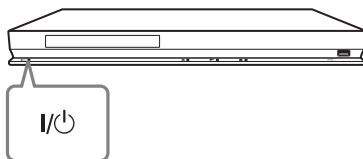

3 Turn on the TV, then switch the input selector on your TV so that the signal from the player appears on your TV screen.

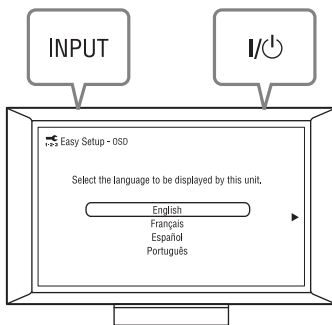

4 Perform "Easy Setup."

Follow the on-screen instructions to make the basic settings using ←/↑/↓/→ and ENTER on the remote.

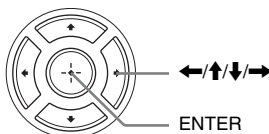

Connecting to the Network

Wired Setup

Use a LAN cable to connect to the LAN (100) terminal on the player.

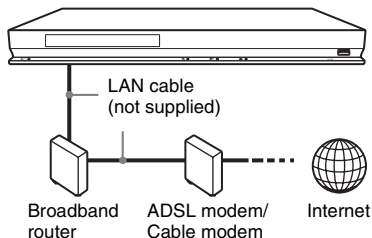

To set the network settings

Select “Network Settings,” “Internet Settings,” then “Wired Setup” (page 26), and follow the on-screen instructions to complete the setup.

Wireless Setup

Use a wireless LAN that is built into the player.

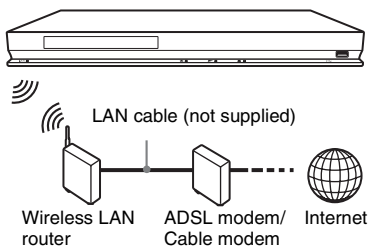

To set the network settings

Select “Network Settings,” “Internet Settings,” then “Wireless Setup” (page 26), and follow the on-screen instructions to complete the setup.

Playback

Playing a Disc

For playable discs, see “Playable discs” (page 32).

- 1** Switch the input selector on your TV so that the signal from the player appears on your TV screen.
- 2** Press **▲ OPEN/CLOSE**, and place a disc on the disc tray.

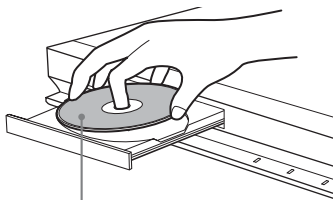

Playing side facing down

- 3** Press **▲ OPEN/CLOSE** to close the disc tray.

● appears on the home menu and playback starts.

If playback does not start automatically, select **●** in the **📺** (Video), **🎵** (Music), or **📷** (Photo) category, and press ENTER.

Enjoying BONUSVIEW/BD-LIVE

Some BD-ROMs with “BD-LIVE Logo*” have bonus content and other data that can be downloaded for enjoyment.

* **BD LIVE™**

- 1** Prepare for BONUSVIEW/BD-LIVE.
 - Connect the player to a network (page 15).
 - Set “BD Internet Connection” to “Allow” (page 24).
- 2** Insert a BD-ROM with BONUSVIEW/BD-LIVE.

The operation method differs depending on the disc. Refer to the instruction manual supplied with the disc.



To delete data in the internal memory or USB memory, select “Erase BD Data” in the (Video), and press ENTER. When the USB memory is used as local storage, all data stored in the buda/budb folder will be erased.

Displaying the play information

You can check the playback information, etc., by pressing DISPLAY. The displayed information differs depending on the disc type and player status.

Example: when playing a BD-ROM

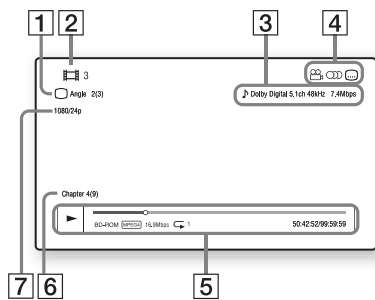

- 1 The currently selected angle
- 2 Title number or name
- 3 The currently selected audio setting
- 4 Available functions (angle, audio, subtitle)
- 5 Playback information
Displays the Play mode, Playing status bar, Disc type, Video codec, Bitrate, and Repeat type.
- 6 Chapter number
- 7 Output resolution/Video frequency

Playing from a USB Device

You can play video/music/photo files on the connected USB device.

For playable USB devices, see “Playable types of files” (page 33).

1 Connect the USB device to the USB jack on the player.

Refer to the instruction manual supplied with the USB device before connecting.

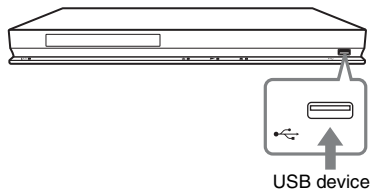







2 Select (Video), (Music), or (Photo) on the home menu using /→.

3 Select (USB device) using /↓, and press ENTER.

Playing via a Network

Streaming BRAVIA Internet Video





Serves as a gateway delivering the selected Internet content and a variety of on-demand entertainment straight to your player.

- 1 Prepare for BRAVIA Internet Video.**
Connect the player to a network (page 15).
- 2 Select  (Video),  (Music), or  (Photo) on the home menu using /.**
- 3 Select an Internet content provider icon using /, and press ENTER.**
When an Internet content list has not been acquired, an unacquired icon or a new icon is displayed.

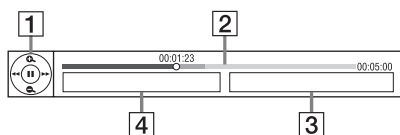
To use the control panel

The control panel appears when the video file starts playing. The displayed items may differ depending on Internet content providers. To display again, press DISPLAY.



- 1 Control display**
Press /// or ENTER for playback operations.
- 2 Playing status bar**
Status bar, Cursor indicating the current position, Playing time, Duration of the video file
- 3 The next video file name**
- 4 The currently selected video file name and rating**

Available Options

Various settings and playback operations are available by pressing OPTIONS. The available items differ depending on the situation.

Common options

| Items | Details |
|-----------------------|---|
| Playback History List | Displays a title in playback history of BD-ROM/DVD-ROM/CD-DA based on Gracenote technology. |
| Repeat Setting | Sets the repeat mode. |
| Favorites List | Displays the Favorites List. |
| Play/Stop | Starts or stops the playback. |
| Play from beginning | Plays the item from the beginning. |
| Information Display | Displays information on the BD-ROM/DVD-ROM/CD-DA based on Gracenote technology. |
| Add to Favorites | Adds Internet content to the Favorites List. |
| Remove from Favorites | Removes Internet content from the Favorites List. |

(Video) only

| Items | Details |
|----------------|---|
| AV SYNC | Adjusts the gap between picture and sound, by delaying the sound output in relation to the picture output (0 to 120 milliseconds). |
| Video Settings | <ul style="list-style-type: none">• Picture Quality Mode: Selects the picture settings for different lighting environments.• FNR: Reduces the random noise appearing in the picture.• BNR: Reduces the mosaic-like block noise in the picture.• MNR: Reduces minor noise around the picture outlines (mosquito noise). |
| Play/Pause | Starts or pauses the playback. |

| Items | Details |
|----------------------------|--|
| Top Menu | Displays the BD's or DVD's Top Menu. |
| Menu/Popup Menu | Displays the BD-ROM's Pop-up Menu or DVD's menu. |
| Title Search | Searches for a title on BD-ROMs/DVD VIDEOS and starts playback from the beginning. |
| Chapter Search | Searches for a chapter and starts playback from the beginning. |
| Angle | Switches to other viewing angles when multi-angles are recorded on BD-ROMs/DVD VIDEOS. |
| IP Content Noise Reduction | Adjusts the picture quality of Internet content. |





(Photo) only











| Items | Details |
|-----------------|---|
| Slideshow Speed | Changes the slideshow speed. |
| Slideshow | Plays a slideshow. |
| Rotate Left | Rotates the photo counterclockwise by 90 degrees. |
| Rotate Right | Rotates the photo clockwise by 90 degrees. |

Settings and Adjustments

Using the Settings Displays

Select  (Setup) on the home menu when you need to change the settings of the player. The default settings are underlined.

- 1 Select  (Setup) on the home menu using /.
- 2 Select the setup category icon using /, and press ENTER.

| Icon | Explanation |
|--|--|
|  | Network Update (page 21) Updates the software of the player. |
|  | Screen Settings (page 21) Makes the video settings according to the type of connecting jacks. |
|  | Audio Settings (page 23) Makes the audio settings according to the type of connecting jacks. |
|  | BD/DVD Viewing Settings (page 24) Makes detailed settings for BD/DVD playback. |
|  | Parental Control Settings (page 24) Makes detailed settings for the Parental Control function. |
|  | Music Settings (page 25) Makes detailed settings for Super Audio CD playback. |
|  | System Settings (page 25) Makes the player-related settings. |
|  | Network Settings (page 26) Makes detailed settings for the Internet and network. |
|  1·2·3 | Easy Setup (page 27) Re-runs the Easy Setup to make the basic settings. |
|  | Resetting (page 27) Resets the player to the factory settings. |

Network Update

Select “OK” to update the player’s software via the network.



- We recommend the network update every 2 months or so.
- For information about update functions, visit the following website:
<http://www.sony.com/bluraysupport/>

Screen Settings

TV Type

| | |
|-------------|--|
| <u>16:9</u> | Select this when connecting to a wide-screen TV or a TV with a wide mode function. |
| 4:3 | Select this when connecting to a 4:3 screen TV without a wide mode function. |

Screen Format

| | |
|--------------------|---|
| <u>Original</u> | Select this when connecting to a TV with a wide mode function. Displays a 4:3 screen picture in 16:9 aspect ratio even on a wide-screen TV. |
| Fixed Aspect Ratio | Changes the picture size to fit the screen size with the original picture aspect ratio. |

DVD Aspect Ratio

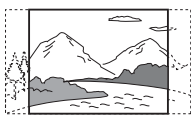
| | |
|-------------------|---|
| <u>Letter Box</u> | Displays a wide picture with black bands on the top and bottom.  |
| Pan & Scan | Displays a full-height picture on the entire screen, with trimmed sides.  |

Cinema Conversion Mode

| | |
|-------------|--|
| <u>Auto</u> | Normally select this. The player automatically detects whether the material is video-based or film-based, and switches to the appropriate conversion method. |
| Video | The conversion method suited for video-based material will always be selected regardless of the material. |

Output Video Format

| | |
|-----------------|--|
| HDMI | Normally select “Auto.” Select “Original Resolution” to output the resolution recorded on the disc. When the resolution is lower than the SD resolution, it is scaled up to the SD resolution. |
| Component Video | Select the resolution that suits your TV. |
| <u>Video</u> | Automatically sets the lowest resolution. |



- When connecting the HDMI OUT jack and other video output jacks at the same time, select “Component Video.”
- If no picture appears when setting “HDMI” or “Component Video” resolution, try another resolution setting.

BD/DVD-ROM 1080/24p Output

| | |
|-------------|---|
| <u>Auto</u> | Outputs 1920 × 1080p/ 24 Hz video signals only when connecting a 1080/ 24p-compatible TV using the HDMI OUT jack. |
| Off | Select this when your TV is not compatible with 1080/ 24p video signals. |

YCbCr/RGB (HDMI)

| | |
|---------------|--|
| <u>Auto</u> | Automatically detects the connected TV type, and switches to the matching color setting. |
| YCbCr (4:2:2) | Outputs YCbCr 4:2:2 video signals. |
| YCbCr (4:4:4) | Outputs YCbCr 4:4:4 video signals. |
| RGB | Outputs RGB video signals. |

HDMI Deep Color Output

| | |
|-------------|--|
| <u>Auto</u> | Normally select this. |
| 12bit | Outputs 12bit/10bit video signals when the connected TV is compatible with Deep Color. |
| 10bit | |
| Off | Select this when the picture is unstable or colors appear unnatural. |

Pause Mode

| | |
|-------------|--|
| <u>Auto</u> | Normally select this. Dynamic moving pictures appear without blurring. |
| Frame | Displays static pictures at high resolution. |

Audio Settings

Audio (HDMI)

| | |
|-------------|---|
| <u>Auto</u> | Normally select this. Outputs audio signals according to the status of the connected HDMI device. |
| PCM | Outputs PCM signals from the HDMI OUT jack. |

DSD Output Mode

| | |
|------------|---|
| On | Outputs DSD signals from the HDMI OUT jack when playing a Super Audio CD. When "On" is selected, analog signals are not output when playing a Super Audio CD. |
| <u>Off</u> | Outputs PCM signals from the HDMI OUT jack when playing a Super Audio CD. |

BD Audio MIX Setting

| | |
|-----------|---|
| <u>On</u> | Outputs the audio obtained by mixing the interactive and secondary audio to the primary audio. |
| Off | Outputs the primary audio only. Select this to output HD audio signals to an AV amplifier (receiver). |

Dolby Digital (Coaxial / Optical)

| | |
|----------------------|--|
| Downmix PCM | Converts to output Linear PCM signals. Select this when connecting an audio device without a built-in Dolby Digital decoder. |
| <u>Dolby Digital</u> | Select this when connecting an audio device with a built-in Dolby Digital decoder. |

DTS (Coaxial / Optical)

| | |
|-------------|---|
| Downmix PCM | Converts to output Linear PCM signals. Select this when connecting to an audio device without a built-in DTS decoder. |
| <u>DTS</u> | Select this when connecting to an audio device with a built-in DTS decoder. |

Audio DRC

| | |
|-------------|--|
| <u>Auto</u> | Performs playback at the dynamic range specified by the disc (BD-ROM only). Other discs are played back at the "Standard" level. |
| Standard | Performs playback at a standard compression level. |
| Wide Range | No compression works. A more dynamic sound is produced. |

Downmix

| | |
|-----------------|--|
| <u>Surround</u> | Outputs audio signals with surround effects. Select this when connecting an audio device that supports Dolby Surround (Pro Logic) or DTS Neo 6. |
| Stereo | Outputs audio signals without surround effects. Select this when connecting an audio device that does not support Dolby Surround (Pro Logic) or DTS Neo 6. |

BD/DVD Viewing Settings

BD/DVD Menu

Selects the default menu language for BD-ROMs or DVD VIDEOS.

When you select “Select Language Code,” the display for entering the language code appears. Enter the code for your language by referring to “Language code list” (page 37).

Audio

Selects the default track language for BD-ROMs or DVD VIDEOS.

When you select “Original,” the language given priority in the disc is selected. When you select “Select Language Code,” the display for entering the language code appears. Enter the code for your language by referring to “Language code list” (page 37).

Subtitle

Selects the default subtitle language for BD-ROMs or DVD VIDEOS.

When you select “Select Language Code,” the display for entering the language code appears. Enter the code for your language by referring to “Language code list” (page 37).

BD Hybrid Disc Playback Layer

| | |
|-----------|------------------------|
| <u>BD</u> | Plays BD layer. |
| DVD/CD | Plays DVD or CD layer. |

BD Internet Connection

| | |
|---------------------|--------------------------------|
| <u>Allow</u> | Normally select this. |
| <u>Do not allow</u> | Prohibits Internet connection. |

BD Data Jack Selection

| | |
|------------------------|--|
| <u>Internal memory</u> | Stores the BD data in the internal memory. |
| USB device (rear) | Stores the BD data in the USB memory connected to the USB jack (rear). |

Parental Control Settings

Password

Sets or changes the password for the Parental Control function. A password allows you to set a restriction on BD-ROM or DVD VIDEO, and Internet video playback. If necessary, you can differentiate the restriction levels for BD-ROMs and DVD VIDEOS.

Parental Control Area Code

Playback of some BD-ROMs, DVD VIDEOS, or Internet videos can be limited according to the geographic area. Scenes may be blocked or replaced with different scenes. Follow the on-screen instructions and enter your four-digit password.

BD Parental Control

Playback of some BD-ROMs can be limited according to the age of the users. Scenes may be blocked or replaced with different scenes. Follow the on-screen instructions and enter your four-digit password.

DVD Parental Control

Playback of some DVD VIDEOS can be limited according to the age of the users. Scenes may be blocked or replaced with different scenes. Follow the on-screen instructions and enter your four-digit password.

Internet Video Parental Control

Playback of some Internet videos can be limited according to the age of the users. Scenes may be blocked or replaced with different scenes. Follow the on-screen instructions and enter your four-digit password.

Internet Video Unrated

| | |
|--------------|---|
| <u>Allow</u> | Allows the playback of unrated Internet videos. |
| Block | Blocks the playback of unrated Internet videos. |

Music Settings

Super Audio CD Playback Layer

| | |
|-----------------------|---------------------------------|
| <u>Super Audio CD</u> | Plays the Super Audio CD layer. |
| CD | Plays the CD layer. |

Super Audio CD Playback Channel

| | |
|------------------|-------------------------------|
| DSD 2ch | Plays the 2ch area. |
| <u>DSD Multi</u> | Plays the multi-channel area. |

System Settings

OSD

Selects your language for the player on-screen displays.

Dimmer

| | |
|---------------|--|
| <u>Bright</u> | Bright lighting. |
| Dark | Low lighting. |
| Off | Turns off the lighting during playback. Low lighting other than during playback. |

Control for HDMI

| | |
|-----------|--|
| <u>On</u> | Allows you to use the "Control for HDMI" function (page 34). |
| Off | Turns off the function. |

Quick Start Mode

| | |
|------------|---|
| On | Shortens the startup time when turning on the player. |
| <u>Off</u> | Reduces standby power consumption. |

Auto Display

| | |
|-----------|---|
| <u>On</u> | Automatically displays information on the screen when changing the viewing titles, picture modes, audio signals, etc. |
| Off | Displays information only when you press DISPLAY. |

Screen Saver

| | |
|-----------|---|
| <u>On</u> | Turns on the screen saver function. The screen saver image appears when you do not use the player for more than 10 minutes while an on-screen display is displayed. |
| Off | Turns off the function. |

Software Update Notification

| | |
|-----|--|
| On | Sets the player to inform you of newer software version information (page 21). |
| Off | Turns off the function. |

Gracenote Settings

| | |
|--------|---|
| Auto | Automatically downloads disc information when disc playback stops. Connect to the network for downloading. |
| Manual | Downloads the disc information when “Playback History List” or “Information Display” is selected in the options menu. |

DivX(R) VOD (Canada models only)

For details, visit the following website:
vod.divx.com

System Information

Displays the player’s software version information and the MAC address.



Network Settings

Internet Settings

Connect the player to the network beforehand. For details, see “Connecting to the Network” (page 15).

| | |
|---------------------|---|
| View Network Status | Displays the current network status. |
| Wired Setup | Select this when you connect to a broadband router directly. |
| Wireless Setup | Select this when you use a wireless LAN router. For further details, visit the following website and check the FAQ contents: http://www.sony.com/bluraysupport/ |

Network Connection Diagnostics

You can run the network diagnostic to check if the network connection has been made properly.

BD Remote Device Registration

Registers your “BD Remote” device.

Registered BD Remote Devices

Displays a list of the registered your “BD Remote” devices.



Easy Setup

Re-runs the “Easy Setup” to make the basic settings. Follow the on-screen instructions.



Resetting

Reset to Factory Default Settings

You can reset the player settings to the factory default by selecting the group of settings. All the settings within the group will be reset.

Initialize Personal Information

You can erase your personal information stored in the player.

Additional Information

Troubleshooting

If you experience any of the following difficulties while using the player, use this troubleshooting guide to help remedy the problem before requesting repairs. Should any problem persist, consult your nearest Sony dealer.

Picture

There is no picture or the picture is not output correctly.

- ➔ Check that all the connecting cables are securely connected (page 12).
- ➔ Switch the input selector on your TV to display the signal from the player.
- ➔ Reset the video output resolution to the lowest resolution by pressing **■** on the player for more than 10 seconds.
- ➔ For HDMI connections, try the following:
 - ① Turn the player off and on again.
 - ② Turn the connected equipment off and on again.
 - ③ Disconnect and then reconnect the HDMI cable.
- ➔ The HDMI OUT jack is connected to a DVI device that does not support copyright protection technology.
- ➔ For HDMI connections, check the “Output Video Format” settings in the “Screen Settings” setup (page 22).
- ➔ When the analog signals are also output, set “BD/DVD-ROM 1080/24p Output” to “Off” in the “Screen Settings” setup (page 22).
- ➔ For BD-ROMs, check the “BD/DVD-ROM 1080/24p Output” setting in the “Screen Settings” setup (page 22).

The display language on the screen switches automatically when connected to the HDMI OUT jack.

- ➔ When “Control for HDMI” is set to “On” (page 25), the display language on the screen automatically switches according to the language setting of the connected TV (if you change the setting on your TV, etc.).

Sound

There is no sound or the sound is not output correctly.

- ➔ Check that all the connecting cables are securely connected (page 12).
- ➔ Switch the input selector on your AV amplifier (receiver) so that the audio signals of the player are output from your AV amplifier (receiver).
- ➔ If the audio signal does not come through the DIGITAL OUT (OPTICAL/COAXIAL)/HDMI OUT jack, check the audio settings (page 23).
- ➔ For HDMI connections, try the following:
 - ① Turn the player off and on again.
 - ② Turn the connected equipment off and on again.
 - ③ Disconnect and then reconnect the HDMI cable.
- ➔ For HDMI connections, if the player is connected to a TV through an AV amplifier (receiver), try connecting the HDMI cable directly to the TV. Refer also to the instruction manual supplied with the AV amplifier (receiver).
- ➔ The HDMI OUT jack is connected to a DVI device (DVI jacks do not accept audio signals).
- ➔ The device connected to the HDMI OUT jack does not support the audio format of the player. Check the audio settings (page 23).

The HD Audio (Dolby Digital Plus, Dolby TrueHD, DTS-HD High Resolution Audio, and DTS-HD Master Audio) is not output by bitstream.

- ➔ Set “BD Audio MIX Setting” to “Off” in the “Audio Settings” setup (page 23).
- ➔ Check that the connected AV amplifier (receiver) is compatible with each HD Audio format.

The interactive audio is not output.

- ➔ Set “BD Audio MIX Setting” to “On” in the “Audio Settings” setup (page 23).

Disc

The disc does not play.

- ➔ The disc is dirty or skewed.
- ➔ The disc is upside down. Insert the disc with the playback side facing down.
- ➔ The disc has a format that cannot be played back by this player (page 32).
- ➔ The player cannot play a recorded disc that is not correctly finalized.
- ➔ The region code on the BD or DVD does not match the player.

USB device

The player does not detect a USB device connected to the player.

- ➔ Make sure that the USB device is securely connected to the USB jack.
- ➔ Check if the USB device or a cable is damaged.
- ➔ Check if the USB device is on.
- ➔ If the USB device is connected via a USB hub, connect the USB device directly to the player.

BRAVIA Internet Video

The picture/sound is poor/certain programs display a loss of detail, especially during fast-motion or dark scenes.

- ➔ Picture/sound quality may be poor depending on Internet content providers.
- ➔ Picture/sound quality may be improved by changing the connection speed. We recommend the connection speed of at least 2.5 Mbps for standard definition video (10 Mbps for high definition video).
- ➔ Not all videos will contain sound.

The picture is small.

- ➔ Press **↑** to zoom in.

Network connection

The player cannot connect to the network.

- ➔ Check the network connection (page 15) and the network settings (page 26).

You cannot connect your PC to the Internet after “Wi-Fi Protected Setup (WPS)” is performed.

- ➔ The wireless settings of the router may change automatically if you use the Wi-Fi Protected Setup function before adjusting the settings of the router. In this case, change the wireless settings of your PC accordingly.

You cannot connect the player to the wireless LAN router.

- ➔ Check if the wireless LAN router is on.
- ➔ Depending on the surrounding environment, such as the wall material, radio wave receiving condition, or obstacles between the player and the wireless LAN router, the communication distance may be shortened. Move the player and the wireless LAN router closer to each other.
- ➔ Devices that use a 2.4 GHz frequency band, such as a microwave, Bluetooth, or digital cordless device, may interrupt the communication. Move the player away from such devices, or turn off such devices.

The desired wireless router is not detected even if “Scan” is performed.

- ➔ Press RETURN to return to the previous screen, and try “Scan” again. If the desired wireless router is still not detected, press RETURN to select “Manual registration.”

The message “A new software version has been found on the network. Perform update under “Network Update.”” appears on the screen when turning the player on.

- ➔ See “Network Update” (page 21) to update the player to a newer software version.

BRAVIA Sync (“Control for HDMI”)

The “Control for HDMI” function does not work (BRAVIA Sync).

- ➔ Check that “Control for HDMI” is set to “On” (page 25).
- ➔ If you change the HDMI connection, turn the player off and on again.
- ➔ If power failure occurs, set “Control for HDMI” to “Off,” then set “Control for HDMI” to “On” (page 25).
- ➔ Check the following and refer to the instruction manual supplied with the component.
 - the connected component is compatible with the “Control for HDMI” function.
 - the connected component’s setting for the “Control for HDMI” function is correct.
- ➔ When you connect the player to a TV through an AV amplifier (receiver),
 - if the AV amplifier (receiver) is not compatible with the “Control for HDMI” function, you may be unable to control the TV from the player.
 - if you change the HDMI connection, disconnect and reconnect the AC power cord, or a power failure occurs, try the following:
 - ① Switch the input selector of the AV amplifier (receiver) so that the picture from the player appears on the TV screen.
 - ② Set “Control for HDMI” to “Off,” then set “Control for HDMI” to “On” (page 25). Refer to the instruction manual supplied with the AV amplifier (receiver).

Others

Playback does not start from the beginning of content.

- ➔ Press **OPTIONS**, and select "Play from beginning."

Playback does not start from the resume point where you last stopped playing.

- ➔ The resume point may be cleared from memory depending on the disc when
 - you open the disc tray.
 - you disconnect the USB device.
 - you play other content.
 - you turn off the player.

The disc tray does not open and "LOCKED" or "TLK ON" appears on the front panel display.

- ➔ When "LOCKED" appears, the player is locked. To cancel the Child Lock, hold down **▶** on the player until "UNLOCK" appears on the front panel display (page 8).
- ➔ When "TLK ON" appears, contact your Sony dealer or local authorized Sony service facility.

The disc tray does not open and you cannot remove the disc even after you press **▲**.

- ➔ Try the following: ①Turn the player off, and disconnect the AC power cord. ②Reconnect the AC power cord while pressing down **▲** on the player. ③Keep pressing down **▲** on the player until the tray opens. ④Remove the disc. ⑤When "WAIT" appears on the front panel display, hold down **I/⏻** on the player for more than 10 seconds until the player turns on again.

"Exxxxx" or "FAN ERR" appears on the front panel display.

- ➔ When "Exxxxx" appears, contact your nearest Sony dealer or local authorized Sony service facility and give the error code.
- ➔ When "FAN ERR" appears, try the following: ①Check that the ventilation holes on the rear of the player are not blocked. ②Place the player in a location with adequate ventilation to prevent heat build-up in the player.

The player does not respond to any button.

- ➔ Moisture has condensed inside the player (page 4).
- ➔ Hold down **I/⏻** on the player for more than 10 seconds until the indicators on the front panel display turn off. If the player still does not respond to any button, disconnect then reconnect the AC power cord.

Specifications

System

Laser: Semiconductor laser

Inputs and outputs

(Jack name:

Jack type/Output level/Load impedance)

LINE OUT R-AUDIO-L:

Phono jack/2 Vrms/10 kilohms

DIGITAL OUT (OPTICAL):

Optical output jack/-18 dBm

(wave length 660 nm)

DIGITAL OUT (COAXIAL):

Phono jack/0.5 Vp-p/75 ohms

HDMI OUT:

HDMI 19-pin standard connector

COMPONENT VIDEO OUT

(Y, P_B, P_R):

Phono jack/Y: 1.0 Vp-p/

P_B, P_R: 0.7 Vp-p/75 ohms

LINE OUT VIDEO:

Phono jack/1.0 Vp-p/75 ohms

LAN (100):

100BASE-TX Terminal

USB:

USB jack Type A (For connecting a USB memory, memory card reader, digital still camera, and digital video camera)

Wireless

Wireless LAN standard:

IEEE802.11a/b/g/n

Frequency range:

U.S. models:

2.4 GHz band: Channels 1-11

5 GHz band: Channels 36-64, 100-140, 149-165

Canada models:

2.4 GHz band: Channels 1-11

5 GHz band: Channels 36-64, 100-116, 132-140, 149-165

Modulation:

DS-SS Modem and OFDM Modem

General

Power requirements:

120 V AC, 60 Hz

Power consumption:

24 W

Dimensions (approx.):

430 mm × 219 mm × 46 mm

(17 in. × 8 5/8 in. × 1 13/16 in.)

(width/depth/height) incl. projecting parts

Mass (approx.):

2.3 kg (5 lb 1 1/8 oz)

Operating temperature:

5 °C to 35 °C (41 °F to 95 °F)

Operating humidity:

25 % to 80 %

Supplied accessories

See page 11.

Specifications and design are subject to change without notice.

Playable discs

| | |
|-----------------------------------|--|
| Blu-ray Disc ^{*1} | BD-ROM BD-R ^{*2} /BD-RE ^{*2} |
| DVD ^{*3} | DVD-ROM DVD-R/DVD-RW DVD+R/DVD+RW |
| CD ^{*3} | CD-DA (Music CD) CD-ROM CD-R/CD-RW Super Audio CD |

^{*1} Since the Blu-ray Disc specifications are new and evolving, some discs may not be playable depending on the disc type and the version. The audio output differs depending on the source, connected output jack, and selected audio settings.

^{*2} BD-RE: Ver.2.1
BD-R: Ver.1.1, 1.2, 1.3 including organic pigment type BD-R (LTH type)
The BD-Rs recorded on a PC cannot be played if postscripts are recordable.

^{*3} A CD or DVD disc will not play if it has not been correctly finalized. For more information, refer to the instruction manual supplied with the recording device.

Discs that cannot be played

- BDs with cartridge
- DVD-RAMs
- HD DVDs
- DVD Audio discs
- PHOTO CDs
- Data part of CD-Extras
- VCDs/Super VCDs
- Audio material side on DualDiscs
- A disc recorded in a color system other than NTSC, such as PAL (this player conforms to the NTSC color system).

Note on Discs

This product is designed to playback discs that conform to the Compact Disc (CD) standard. DualDiscs and some of the music discs encoded with copyright protection technologies do not conform to the Compact Disc (CD) standard, therefore, these discs may not be playable by this product.

Note on playback operations of BDs/DVDs

Some playback operations of BDs/DVDs may be intentionally set by software producers. Since this player plays BDs/DVDs according to the disc contents the software producers designed, some playback features may not be available.

Note about double-layer BDs/DVDs

The playback pictures and sound may be momentarily interrupted when the layers switch.

Region code (BD-ROM/DVD VIDEO only)

Your player has a region code printed on the rear of the unit and will only play BD-ROMs/DVD-ROMs labeled with identical region codes or .

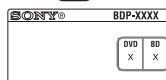

Region code

Playable types of files

Video

| File format | Extensions |
|---|---|
| MPEG-1 Video/PS ^{*1} MPEG-2 Video/PS, TS ^{*1} | “.mpg,” “.mpeg,” “.m2ts,” “.mts” |
| DivX ^{*2} | “.avi,” “.divx” |
| MPEG-4 AVC ^{*1} | “.mkv,” “.mp4,” “.m4v,” “.m2ts,” “.mts” |
| WMV9 ^{*1} | “.wmv,” “.asf” |
| AVCHD | ^{*3} |

Music

| File format | Extensions |
|---------------------------------|------------|
| MP3 (MPEG-1 Audio Layer III) | “.mp3” |
| AAC ^{*1*4} | “.m4a” |
| WMA9 Standard ^{*1*4} | “.wma” |
| LPCM | “.wav” |

Photo

| File format | Extensions |
|-------------|-----------------|
| JPEG | “.jpg,” “.jpeg” |

^{*1} The player does not play coded files such as DRM.

^{*2} Canada models only

ABOUT DIVX VIDEO: DivX[®] is a digital video format created by DivX, Inc. This is an official DivX Certified device that plays DivX video. Visit www.divx.com for more information and software tools to convert your files into DivX video.

ABOUT DIVX VIDEO-ON-DEMAND: This DivX Certified[®] device must be registered in order to play DivX Video-on-Demand (VOD) content. To generate the registration code, locate the DivX VOD section in the device setup menu. Go to vod.divx.com with this code to complete the registration process and learn more about DivX VOD.

^{*3} The player plays AVCHD format files that are recorded on a digital video camera, etc. The AVCHD format disc will not play if it has not been correctly finalized.



^{*4} The player does not play coded files such as Lossless.



- Some files may not play depending on the format, the encoding, or recording condition.
- Some files edited on a PC may not play.
- The player can recognize the following files or folders in BDs, DVDs, CDs and USB devices:
 - up to folders in the 5th tree
 - up to 500 files in a single tree
- Some USB devices may not work with this player.
- The player can recognize Mass Storage Class (MSC) devices (such as flash memory or an HDD) that are FAT-compatible and non-partitioned, Still Image Capture Device (SICD) class devices and 101 keyboard (front USB jack only).
- To avoid data corruption or damage to the USB memory or devices, turn the player off when connecting or removing the USB memory or devices.
- The player may not play high bit rate video files on DATA CDs smoothly. You are recommended to play such files using DATA DVDs.

About the BRAVIA Sync features (for HDMI connections only)

By connecting Sony components that are compatible with the “Control for HDMI” function with an HDMI cable (supplied with BDP-BX57 only), operation is simplified as below:

- **One-Touch Play**
With one touch of the following buttons, the connected TV turns on and the input selector on the TV is switched to the player automatically.
 - : HOME: The home menu appears automatically (page 10, 16, 20).
 - : PLAY: Playback starts automatically.
- **System Power-Off**
When you turn off the TV using -TV-  or the power button on the TV’s remote, the player and HDMI-compatible components turn off automatically.

- **Theater**

When you press THEATER, the player automatically switches to the optimum video mode for watching movies. When connected with a Sony AV amplifier (receiver) using the HDMI cable, the speaker output also switches automatically. When connected with a Theater Mode-compatible TV using the HDMI cable, the TV’s video mode switches to Theater Mode. Press the button again to return to the original setting.

- **Language Follow**

When you change the language for the on-screen display on your TV, the player’s language for the on-screen display is also changed after turning the player off and on.

To prepare for the BRAVIA Sync features

Set “Control for HDMI” to “On” in the “System Settings” setup (page 25).

For details on settings of your TV or other connected components, refer to the instruction manual supplied with the TV or components.



- When connecting the Sony TV that is compatible with the “Control for HDMI” Easy Setting function using the HDMI cable, the “Control for HDMI” setting of the player automatically switches to “On” if the “Control for HDMI” setting on the connected TV is set to “On.” Refer to the instruction manual supplied with the TV.
- When connecting the Sony TV that is compatible with the BRAVIA Sync features using the HDMI cable, you can control the basic functions of the player with the TV’s remote if the “Control for HDMI” setting on the connected TV is set to “On.” Refer to the instruction manual supplied with the TV.



Depending on the connected component, the “Control for HDMI” function may not work. Refer to the instruction manual supplied with the component.

About wireless LAN security

Since communication via the wireless LAN function is established by radio waves, the wireless signal may be susceptible to interception. To protect wireless communication, this player supports various security functions. Be sure to correctly configure the security settings in accordance with your network environment.

◆ No Security

Although you can easily make settings, anyone can intercept wireless communication or intrude into your wireless network, even without any sophisticated tools. Keep in mind that there is a risk of unauthorized access or interception of data.

◆ WEP

WEP applies security to communications to prevent outsiders from intercepting communications or intruding into your wireless network. WEP is a legacy security technology that enables older devices, which do not support TKIP/AES, to be connected.

◆ WPA-PSK (TKIP), WPA2-PSK (TKIP)

TKIP is a security technology developed to correct for the deficiencies of WEP. TKIP assures a higher security level than WEP.

◆ WPA-PSK (AES), WPA2-PSK (AES)

AES is a security technology that uses an advanced security method that is distinct from WEP and TKIP.

AES assures a higher security level than WEP or TKIP.

Copyrights and Trademarks

- This product incorporates copyright protection technology that is protected by U.S. patents and other intellectual property rights. Use of this copyright protection technology must be authorized by Macrovision, and is intended for home and other limited viewing uses only unless otherwise authorized by Macrovision. Reverse engineering or disassembly is prohibited.
- “AVCHD” and the “AVCHD” logo are trademarks of Panasonic Corporation and Sony Corporation.
- Java and all Java-based trademarks and logos are trademarks or registered trademarks of Sun Microsystems, Inc.
- “XMB,” and “xross media bar” are trademarks of Sony Corporation and Sony Computer Entertainment Inc.
- This product incorporates High-Definition Multimedia Interface (HDMI™) technology. HDMI, the HDMI logo and High-Definition Multimedia Interface are trademarks or registered trademarks of HDMI Licensing LLC.
- “Blu-ray Disc” is a trademark.
- “Blu-ray Disc,” “DVD+RW,” “DVD-RW,” “DVD+R,” “DVD-R,” “DVD VIDEO,” and “CD” logos are trademarks.
- “BD-LIVE,” “BD-LIVE” logo, and “BONUSVIEW” are trademarks of Blu-ray Disc Association.
- “x.v.Color” and “x.v.Color” logo are trademarks of Sony Corporation.
- “BRAVIA” is a trademark of Sony Corporation.
- “PhotoTV HD” and the “PhotoTV HD” logo are trademarks of Sony Corporation.
- MPEG Layer-3 audio coding technology and patents licensed from Fraunhofer IIS and Thomson.
- DivX®, DivX Certified® and associated logos are registered trademarks of DivX, Inc. and are used under license (Canada models only).
- This product meets ENERGY STAR® guidelines for energy efficiency. ENERGY STAR and the ENERGY STAR mark are registered U.S. marks. ENERGY STAR is a registered mark owned by the U.S. government.

- Music and video recognition technology and related data are provided by Gracenote®. Gracenote is the industry standard in music recognition technology and related content delivery. For more information, please visit www.gracenote.com. CD, DVD, Blu-ray Disc, and music and video-related data from Gracenote, Inc., copyright © 2000-present Gracenote. Gracenote Software, copyright © 2000-present Gracenote. One or more patents owned by Gracenote apply to this product and service. See the Gracenote website for a nonexhaustive list of applicable Gracenote patents. Gracenote, CDDDB, MusicID, MediaVOCS, the Gracenote logo and logotype, and the “Powered by Gracenote” logo are either registered trademarks or trademarks of Gracenote in the United States and/or other countries.



- The Wi-Fi CERTIFIED™ Logo is a certification mark of the Wi-Fi Alliance.
- The Wi-Fi Protected Setup™ Mark is a mark of the Wi-Fi Alliance.
- “Wi-Fi CERTIFIED™” and “Wi-Fi Protected Setup™” are trademarks of the Wi-Fi Alliance.
- Other system and product names are generally trademarks or registered trademarks of the manufacturers. ™ and ® marks are not indicated in this document.

Code numbers of controllable TVs

If more than one code number is listed, try entering them one at a time until you find the one that works with your TV.

| Manufacturer | Code number |
|----------------|--------------|
| Sony | 01 (default) |
| Hitachi | 02 |
| LG/Goldstar | 04 |
| Mitsubishi/MGA | 13 |
| NEC | 04 |
| Panasonic | 19 |
| Philips | 21 |
| Pioneer | 16 |
| RCA | 10 |
| Samsung | 20 |
| Sharp | 18 |
| Toshiba | 07 |

Language code list

For details, see “BD/DVD Viewing Settings” (page 24).

The language spellings conform to the ISO 639: 1988 (E/F) standard.

Code Language

| | | | | | | | |
|------|-------------------|------|------------------|------|------------------|------|------------------|
| 1027 | Afar | 1186 | Scots Gaelic | 1349 | Macedonian | 1511 | Albanian |
| 1028 | Abkhazian | 1194 | Galician | 1350 | Malayalam | 1512 | Serbian |
| 1032 | Afrikaans | 1196 | Guarani | 1352 | Mongolian | 1513 | Siswati; Swati |
| 1039 | Amharic | 1203 | Gujarati | 1353 | Moldavian | 1514 | Sesotho; Sotho |
| 1044 | Arabic | 1209 | Hausa | 1356 | Marathi | | southern |
| 1045 | Assamese | 1217 | Hindi | 1357 | Malay | 1515 | Sundanese |
| 1051 | Aymara | 1226 | Croatian | 1358 | Malese; Maltese | 1516 | Swedish |
| 1052 | Azerbaijani | 1229 | Hungarian | 1363 | Burmese | 1517 | Swahili |
| 1053 | Bashkir | 1233 | Armenian | 1365 | Nauru | 1521 | Tamil |
| 1057 | Byelorussian | 1235 | Interlingua | 1369 | Nepali | 1525 | Telugu |
| 1059 | Bulgarian | 1239 | Interlingue | 1376 | Dutch | 1527 | Tajik |
| 1060 | Bihari | 1245 | Inupiak | 1379 | Norwegian | 1528 | Thai |
| 1061 | Bislama | 1248 | Indonesian | 1393 | Occitan | 1529 | Tigrinya |
| 1066 | Bengali | 1253 | Icelandic | 1403 | Oromo | 1531 | Turkmen |
| 1067 | Tibetan | 1254 | Italian | 1408 | Oriya | 1532 | Tagalog |
| 1070 | Breton | 1257 | Hebrew | 1417 | Punjabi; Panjabi | 1534 | Setswana; Tswana |
| 1079 | Catalan | 1261 | Japanese | 1428 | Polish | 1535 | Tonga; |
| 1093 | Corsican | 1269 | Yiddish | 1435 | Pashto; Pushto | | Tonga islands |
| 1097 | Czech | 1283 | Javanese | 1436 | Portuguese | 1538 | Turkish |
| 1103 | Welsh | 1287 | Georgian | 1463 | Quechua | 1539 | Tsonga |
| 1105 | Danish | 1297 | Kazakh | 1481 | Rhaeto-Romance | 1540 | Tatar |
| 1109 | German | 1298 | Greenlandic; | 1482 | Kirundi; Rundi | 1543 | Twi |
| 1130 | Bhutani; Dzongkha | | Kalaallisut | 1483 | Romanian | 1557 | Ukrainian |
| 1142 | Greek | 1299 | Cambodian; Khmer | 1489 | Russian | 1564 | Urdu |
| 1144 | English | 1300 | Kannada | 1491 | Kinyarwanda | 1572 | Uzbek |
| 1145 | Esperanto | 1301 | Korean | 1495 | Sanskrit | 1581 | Vietnamese |
| 1149 | Spanish | 1305 | Kashmiri | 1498 | Sindhi | 1587 | Volapük |
| 1150 | Estonian | 1307 | Kurdish | 1501 | Sangho; Sango | 1613 | Wolof |
| 1151 | Basque | 1311 | Kirghiz | 1502 | Serbo-Croatian | 1632 | Xhosa |
| 1157 | Persian | 1313 | Latin | 1503 | Singhalese; | 1665 | Yoruba |
| 1165 | Finnish | 1326 | Lingala | | Sinhalese | 1684 | Chinese |
| 1166 | Fiji | 1327 | Laothian; Lao | 1505 | Slovak | 1697 | Zulu |
| 1171 | Faroese | 1332 | Lithuanian | 1506 | Slovenian | 1703 | not specified |
| 1174 | French | 1334 | Latvian | 1507 | Samoaan | | |
| 1181 | Frisian | 1345 | Malagasy | 1508 | Shona | | |
| 1183 | Irish | 1347 | Maori | 1509 | Somali | | |

Parental control/area code

For details, see “Parental Control Area Code” (page 24).

Number, Area (Code)

| | | |
|----------------------|------------------------|---------------------------|
| 2044, Argentina (ar) | 2219, Hong Kong (hk) | 2427, Pakistan (pk) |
| 2047, Australia (au) | 2248, India (in) | 2424, Philippines (ph) |
| 2046, Austria (at) | 2238, Indonesia (id) | 2428, Poland (pl) |
| 2057, Belgium (be) | 2239, Ireland (ie) | 2436, Portugal (pt) |
| 2070, Brazil (br) | 2254, Italy (it) | 2489, Russia (ru) |
| 2090, Chile (cl) | 2276, Japan (jp) | 2501, Singapore (sg) |
| 2092, China (cn) | 2304, Korea (kr) | 2149, Spain (es) |
| 2093, Colombia (co) | 2333, Luxembourg (lu) | 2499, Sweden (se) |
| 2115, Denmark (dk) | 2363, Malaysia (my) | 2086, Switzerland (ch) |
| 2165, Finland (fi) | 2362, Mexico (mx) | 2543, Taiwan (tw) |
| 2174, France (fr) | 2376, Netherlands (nl) | 2528, Thailand (th) |
| 2109, Germany (de) | 2390, New Zealand (nz) | 2184, United Kingdom (gb) |
| 2200, Greece (gr) | 2379, Norway (no) | |

Index

Words in quotations appear in the on-screen displays.

A

AUDIO 9
“Audio Settings” 23

B

Batteries 11
“BD/DVD Viewing Settings” 24
BD-LIVE 16
BD-R 32
BD-RE 32
Bitstream 29
Blu-ray Disc 32
BONUSVIEW 16
BRAVIA Internet Video 18
BRAVIA Sync 30, 34

C

CD 32
Child Lock 8, 31
Color buttons 9
Connecting
 AV amplifier
 (Receiver) 13
 Network 15
 TV 12
“Control for HDMI” 25, 30, 34

D

Deep Color 22
“Dimmer” 25
DISPLAY 10
Dolby Digital 23
“DSD Output Mode” 23
DTS 23
DVD 32

E

“Easy Setup” 14, 27

F

FAVORITES 9

G

“Gracenote Settings” 26

H

HDMI 22, 23
HOME 10, 20
Home menu 20

I

Internet content 9, 18

L

Language Follow 34

M

MAC address 26
“Music Settings” 25

N

“Network Settings” 26
“Network Update” 21

O

One-Touch Play 34
OPTIONS 9
“OSD” 25

P

Parental Control 24
“Parental Control Settings” 24
Play information 17
Playable discs 32
POP UP/MENU 9

Q

“Quick Start Mode” 25

R

Region code 33
Remote 9, 11
“Resetting” 27
Resetting the player 27
Resume 10, 31

S

“Screen Settings” 21
“Setup” 20
Software update 21, 26
SUBTITLE 9
System Power-Off 34
“System Settings” 25

T

THEATER 9, 34
TOP MENU 9
Troubleshooting 28
“TV Type” 21

U

Update 21
USB 17

W

WEP 35
WPA2-PSK (AES) 35
WPA2-PSK (TKIP) 35
WPA-PSK (AES) 35
WPA-PSK (TKIP) 35

